

# ELITE ELEVATOR



Contact Name: \_\_\_\_\_

Job Name: \_\_\_\_\_

Email Address: \_\_\_\_\_

Location: \_\_\_\_\_

**NOTES**

**BASE PACKAGE**

Includes 2 landings, 1 opening, cab model 3636 or 3648, winding drum drivetrain, 8lb. guide rails, travel cable, PLC controller and optical landing system, terminal and final limits, 2 recessed LED automatic cab lights, stainless steel fixtures with blue LED buttons, phone, standard flat wall cab finish, 1 door lock per level.

**HOISTWAY**

**Hoistway Size**

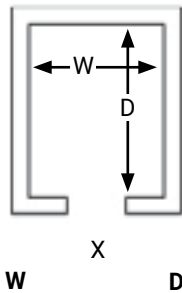

**Rail Location**

LEFT

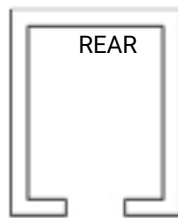

RIGHT

**Landings**

2	5
3	6
4	7

**Hoistway Construction**

- Wood
- Concrete

Note: Refer to Master Cab Configuration file for recommended standard hoistway sizes.

**CAB**

**Cab Model**

- 3636
- 3648
- 3660
- 4254
- 4836

**Cab Configuration**

- Front Opening
- Pass Through
- 90 degree opening

**Cab Height**

- 6' 8"
- 7' 0"
- 8' 0"

**CAB FINISHES**

**Standard Flat Laminate**



- Finish
- White
  - Beige
  - Black
  - Other

**Flat Wood Veneer**



- Unfinished
- Birch
  - Oak
  - Cherry
  - Mahogany

**Traditional**

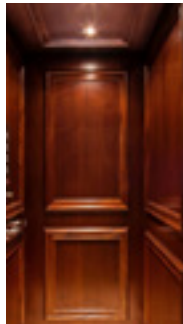

- Unfinished
- Birch
  - Oak
  - Cherry
  - Mahogany

**Shaker Style**

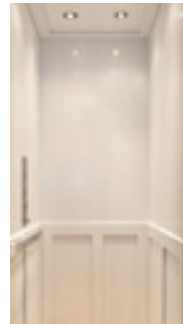

- Finish
- White
  - Unfinished
  - Birch

**Lights**



2 LED



4 LED







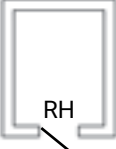
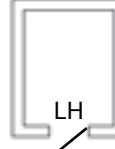
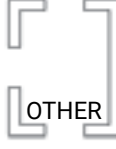
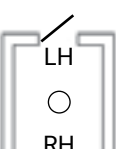
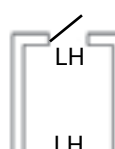
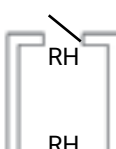
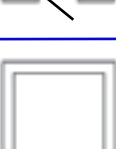
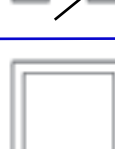

**Fixture Finish**

- #4 Brushed Stainless
- Bronze
- Copper Vein

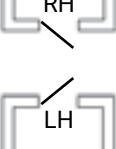
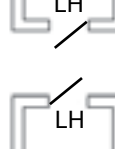
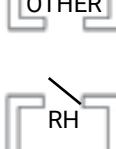
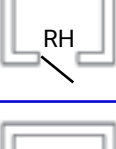
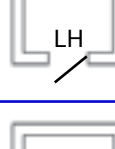
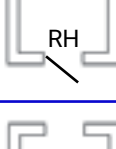
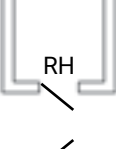
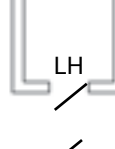
**Fixture Shape**

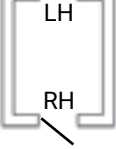
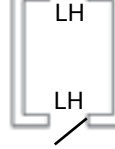
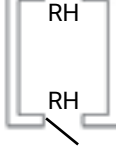
- Traditional
- Oval

Select hoistway door configuration for each floor level.

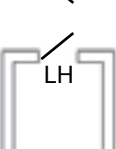
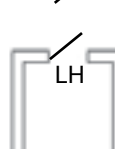
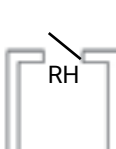
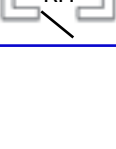
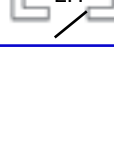
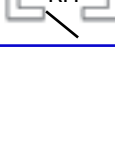
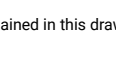
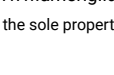
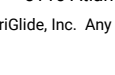
<b>DOOR SWING</b>	<b>LEVEL 4</b>			
				
				
				
				
				
	<b>LEVEL 3</b>			
				
				
				
				
<b>LEVEL 2</b>				
<b>LEVEL 1</b>				

Please fill in all blank fields.

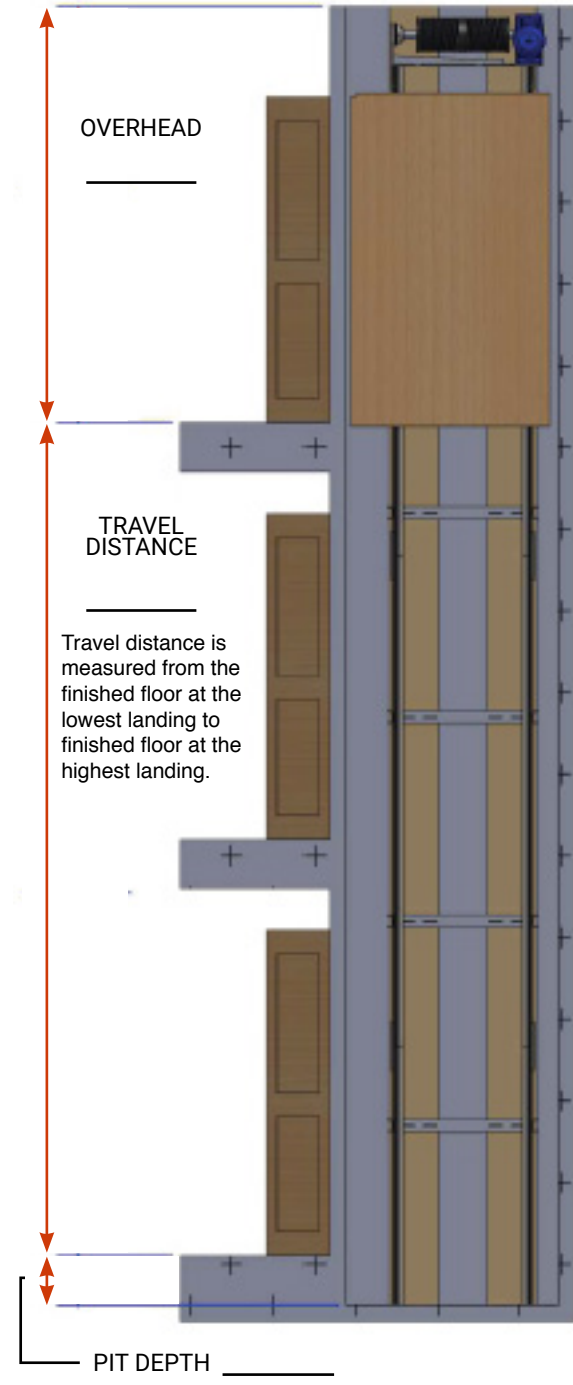

**OVERHEAD** \_\_\_\_\_

**TRAVEL DISTANCE** \_\_\_\_\_

Travel distance is measured from the finished floor at the lowest landing to finished floor at the highest landing.

**PIT DEPTH** \_\_\_\_\_

**HOISTWAY ELEVATIONS**

~Minimum Recommended Pit Depth - 12"  
 ~Minimum Overhead - 102" for 6'8" cab

# ELITE ELEVATOR



## STANDARD FEATURES

- » PLC Based Controller, ETL Listed
- » Terminal and Final Limits
- » Optical Landing System
- » 2nd Level Homing
- » Blue LED Call Buttons
- » Automatic Cab Lights
- » Travel Cable
- » Cartop Box
- » Phone
- » 2 Drawing Revisions

## OPTIONS

- Battery Lowering w/ e-light
- Additional Door Locks QTY \_\_\_\_\_
- Automatic Gate Operator QTY \_\_\_\_\_
- Security Keypad
- Float Switch
- Door Baffles QTY \_\_\_\_\_
- Custom Platform Size
- Excess Travel Distance \_\_\_\_\_
- Round Handrail
- Additional Drawing Revisions QTY \_\_\_\_\_

## MACHINE ROOM

### Controller/Machine Room Location:

- Adjacent
- Remote \_\_\_\_\_ feet
- Standard Travel Cable (hoistway length + 20ft)
- Extra Travel Cable
- Controller for Stops 5-7

## DRIVE

- Winding Drum - 950 lb. capacity
- Roped Hydraulic

## GATES

### Standard Vinyl

- White
- Tan
- Gray

### Wood Grain Vinyl

- Birch
- Maple
- Natural Oak
- Dark Oak

Unfinished

### Natural Wood Veneer

- Birch
- Maple
- Oak
- Mahogany
- Cherry

### Acrylic

- Clear

## OPTIONAL DOOR JAMBS

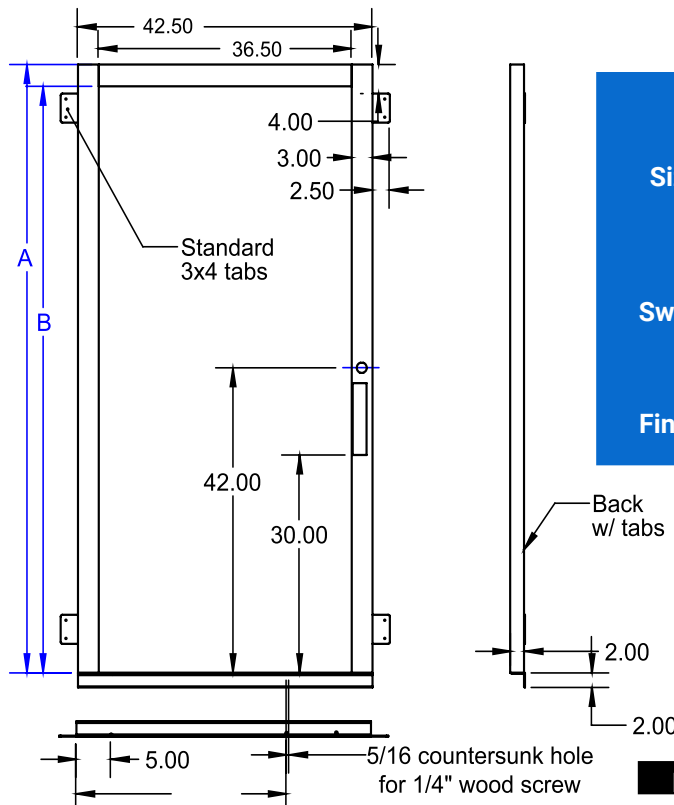

	Quantity
Size	80" _____
	84" _____
	96" _____
Swing	Right _____
	Left _____
Finish	White _____
	Beige _____



36" wide door panel provided by others. Integrated self closing hinge and honeywell realign door lock with LED call button. Strike plate kit included with frame.

Door Size	r/o Frame Size	A	B
36x80	44 x 84.5	83.75	80.75
36x84	44 x 88.5	87.75	84.75
36x96	44 x 100.5	99.75	96.75